

Curriculum Inventory Specification

Version: DRAFT AAMC Point Release – “v10”

Date: 2021-01-06

Author(s): Johmarx Patton

Corresponding Author Email: jpatton@aamc.org

Table of Contents

1.0 Version History.....	3
2.0 MedBiquitous Standards Public License and Terms of Use.....	4
3.0 Acknowledgements.....	5
4.0 Documentation Conventions.....	7
5.0 Conformance.....	8
6.0 Common Data Types	9
6.1 Identifying Data Through XPath.....	9
7.0 Introduction to Curriculum Inventory	10
8.0 Other Standards, Specifications, or Schemas Referenced.....	11
9.0 Curriculum Inventory Schema.....	12
9.1 CurriculumInventory.....	12
9.2 Program.....	18
Program Element Information.....	19
9.3 Events	22
Events Element Information	23
9.3.1 Event.....	24
9.4 Expectations.....	29
Expectations Element Information.....	30
9.5 AcademicLevels.....	32
AcademicLevels Element Information	33
9.6 Level.....	34
Level Element Information.....	35
9.7 Sequence.....	36
Sequence Element Information.....	37
9.7.1 SequenceBlock	38
9.7.2 Timing.....	43
9.7.3 AcademicLevelReferences.....	45
9.7.4 Dates.....	47
9.7.5 SequenceBlockEvent	49
9.8 Integration.....	51
Integration Element Information	52
9.8.1 IntegrationBlock.....	53
10.0 Sample XML Document.....	56
11.0 References.....	61

1.0 Version History

Version No.	Date	Changed By	Changes Made
1.0	2013-04-23		
1.1	2014-05-29	Valerie Smothers	<ul style="list-style-type: none"> Added SequenceBlockLevels element with scheduling attribute and StartingAcademicLevel and EndingAcademicLevel sub-elements. Moved to NonNullStringType defined in common.xsd.
1.11	2014-11-03	Valerie Smothers	<ul style="list-style-type: none"> Changed SequenceBlockLevels to AcademicLevelReferences
DRAFT AAMC Point Release "v10"	2021-01-06	Johmarx Patton	<ul style="list-style-type: none"> Description subelement of CurriculumInventory element made optional instructionalMethodDuration attribute added to InstructionalMethod subelement of Event element

2.0 MedBiquitous Standards Public License and Terms of Use

MedBiquitous Standards (including schemas, specifications, guidelines, sample documents, sample code, Web services description files, and related items) are provided by the copyright holders under the following license. By obtaining, using, and or copying this work, you (the licensee) agree that you have read, understood, and will comply with the following terms and conditions.

The Association of American Medical Colleges (AAMC) hereby grants a perpetual, non-exclusive, non-transferable license to copy, use, display, perform, modify, make derivative works of, and develop the MedBiquitous Standards for any use and without any fee or royalty, provided that you include the following on ALL copies of the MedBiquitous Standards or portions thereof, including modifications, that you make:

1. Any pre-existing intellectual property disclaimers, notices, or terms and conditions. If none exist, the following notice should be used: "Copyright [date of release] Association of American Medical Colleges. All Rights Reserved. <http://www.medbiq.org>"
2. Notice of any changes or modification to the MedBiquitous Standards.
3. Notice that any user is bound by the terms of this license and reference to the full text of this license in a location viewable to users of the redistributed or derivative work.

In the event that the licensee modifies any part of the MedBiquitous Standards, it will not then represent to the public, through any act or omission, that the resulting modification is an official specification of the MedBiquitous Standards unless and until such modification is officially adopted.

THE AAMC MAKES NO WARRANTIES OR REPRESENTATIONS, EXPRESS OR IMPLIED, WITH RESPECT TO ANY COMPUTER CODE, INCLUDING SCHEMAS, SPECIFICATIONS, GUIDELINES, SAMPLE DOCUMENTS, WEB SERVICES DESCRIPTION FILES, AND RELATED ITEMS. WITHOUT LIMITING THE FOREGOING, THE AAMC DISCLAIMS ANY IMPLIED WARRANTIES OF MERCHANTABILITY OR FITNESS FOR A PARTICULAR PURPOSE AND ANY WARRANTY, EXPRESS OR IMPLIED, AGAINST INFRINGEMENT BY THE MEDBIQUITOUS STANDARDS OF ANY THIRD PARTY PATENTS, TRADEMARKS, COPYRIGHTS OR OTHER RIGHTS. THE LICENSEE AGREES THAT ALL COMPUTER CODES OR RELATED ITEMS PROVIDED SHALL BE ACCEPTED BY LICENSEE "AS IS". THUS, THE ENTIRE RISK OF NON-PERFORMANCE OF THE MEDBIQUITOUS STANDARDS RESTS WITH THE LICENSEE WHO SHALL BEAR ALL COSTS OF ANY SERVICE, REPAIR OR CORRECTION.

IN NO EVENT SHALL THE AAMC OR CONTRIBUTORS TO THE DEVELOPMENT OF THE MEDBIQUITOUS STANDARDS BE LIABLE TO THE LICENSEE OR ANY OTHER USER FOR DAMAGES OF ANY NATURE, INCLUDING, WITHOUT LIMITATION, ANY GENERAL, DIRECT, INDIRECT, INCIDENTAL, CONSEQUENTIAL, OR SPECIAL DAMAGES, INCLUDING LOST PROFITS, ARISING OUT OF ANY USE OF MEDBIQUITOUS STANDARDS.

LICENSEE SHALL INDEMNIFY THE AAMC AND CONTRIBUTORS TO THE DEVELOPMENT OF THE MEDBIQUITOUS STANDARDS FROM ANY LOSS, CLAIM, DAMAGE OR LIABILITY (INCLUDING, WITHOUT LIMITATION, PAYMENT OF ATTORNEYS' FEES AND COURT COSTS) ARISING OUT OF MODIFICATION OR USE OF THE MEDBIQUITOUS STANDARDS OR ANY RELATED CONTENT OR MATERIAL BY LICENSEE.

LICENSEE SHALL NOT OBTAIN OR ATTEMPT TO OBTAIN ANY PATENTS, COPYRIGHTS OR OTHER PROPRIETARY RIGHTS WITH RESPECT TO THE MEDBIQUITOUS STANDARDS. THIS LICENSE SHALL TERMINATE AUTOMATICALLY IF LICENSEE VIOLATES ANY OF ITS TERMS AND CONDITIONS.

The name and trademarks of the AAMC, including but not limited to MedBiquitous®, and its contributors may NOT be used in advertising or publicity pertaining to MedBiquitous Standards without specific, prior written permission. Title to copyright in MedBiquitous Standards and any associated documentation will at all times remain with the copyright holders.

3.0 Acknowledgements

The development of this specification is made possible as part of an accelerated standards development project funded by the Association of American Medical Colleges.

The MedBiquitous Consortium wishes to acknowledge the MedBiquitous Curriculum Inventory Working Group members, invited experts, and other individuals that contributed to the creation of this document.

Co-chairs:

- Susan Albright, Med:integrate
- Hugh Stoddard, Emory University
- Sascha Cohen, University of California, San Francisco

Members:

- Dmitriy Babichenko, University of Pittsburgh
- Adrian Ballard, Association of American Medical Colleges
- Terri Cameron, Association of American Medical Colleges
- Joshua Jacobs, National University of Singapore
- John Mahoney, University of Pittsburgh
- Quinn Montgomery, Advanced Informatics
- Robby Reynolds, Association of American Medical Colleges
- Al Salas, Association of American Medical Colleges
- Rosalyn Scott, Department of Veterans Affairs
- Nabil Zary, Karolinska Institutet

Invited Experts

- Michael Awad, Washington University School of Medicine
- Leslie Bofill, Florida International University
- Chris Candler, University of Oklahoma Health Sciences Center
- Charles Conway, Online Business Systems
- Rachel Ellaway, Northern Ontario School of Medicine
- Kristi Ferguson, University of Iowa
- Erica Friedman, Mount Sinai Medical Center
- Heather Hageman, Washington University School of Medicine
- Heidi Hays, New Innovations, Inc.
- Alison Loftus, Indiana University School of Medicine
- Cynthia Lybrand, ETSU Quillen College of Medicine
- Lise McCoy, AT Still University
- Tom May, MedHub
- Chandler Mayfield, University of California, San Francisco
- Steve Mitchell, University of New Mexico

- Dan Nelson, New Innovations, Inc.
- Peter Orr, MedHub, Inc.
- Jamie Padmore, MedStar Health
- Brian Rutledge, Mississippi Medical Center
- Paul Schilling, Schilling Consulting, LLC
- Juliane Schneider, Harvard School of Medicine
- James Shumway, West Virginia University School of Medicine
- Kevin Souza, University of California, San Francisco
- Peter Speltz, Vanderbilt University
- Hugh Stoddard, Nebraska Medical Center
- Britta Thompson, University of Oklahoma College of Medicine
- Carrie Thorn, Michigan State University
- Janet Trial, University of Southern California
- Marc Triola, New York University
- Peggy Weissinger, Georgetown University School of Medicine
- David Wiener, Duke University School of Medicine
- Tim Willett, SIM-one

Specification authors also received technical guidance from members of the MedBiquitous Technical Advisory Group.

- James Fiore, NBME
- Prasad Chodavarapu, American Board of Family Medicine
- Mark Trenchard, Emory University
- Scott Kroyer, Ascend Learning
- Adekunle Mumuni, New Innovations

4.0 Documentation Conventions

This document uses the following conventions:

Convention	Description
Bold Text	When used with an XML element name, indicates that the element contains sub-elements.
<i>Italics</i>	When used in an XML element description, an attribute of the XML element.
Monospaced type	Sample XML tags, code, schema, or portion thereof.

The document uses graphics generated by Altova XMLSpy® software, which uses the following graphical conventions:

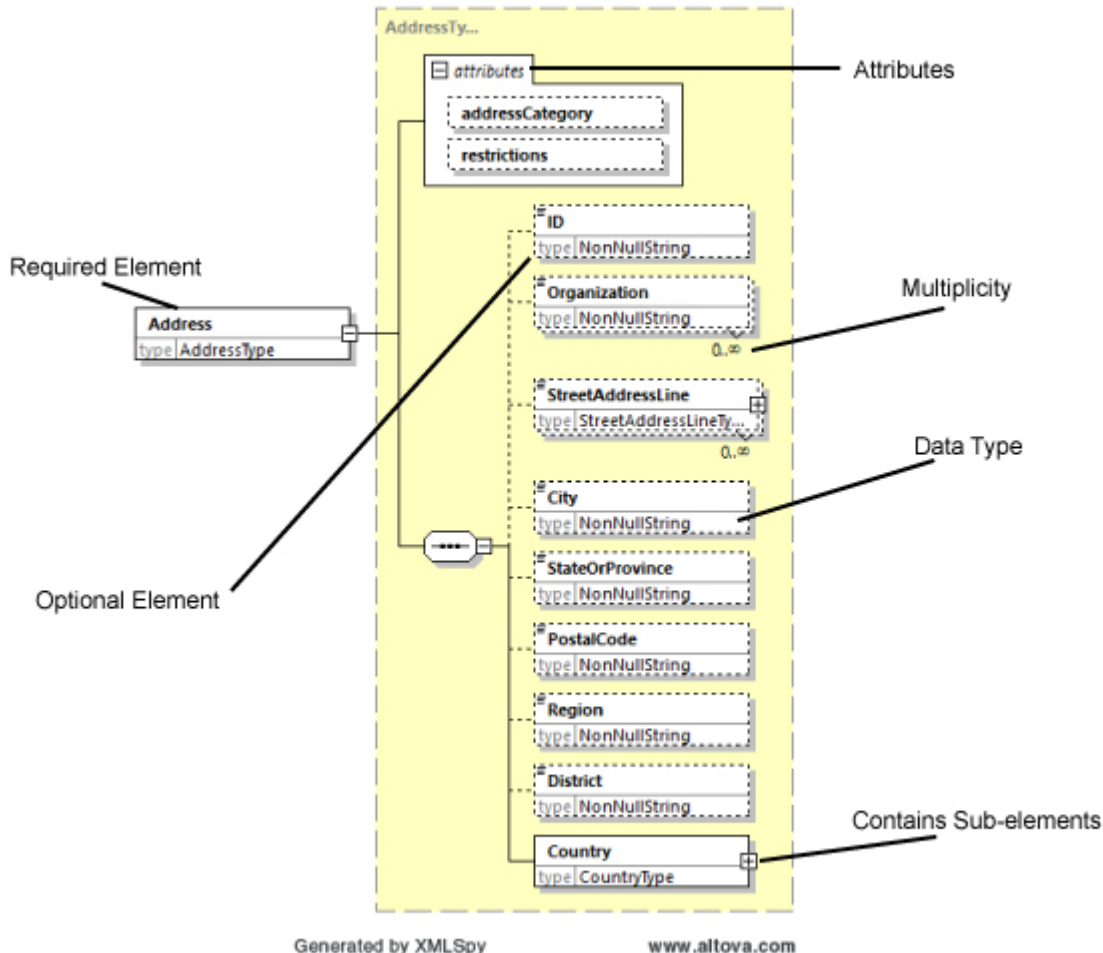

5.0 Conformance

To conform to the MedBiquitous Curriculum Inventory specification, an XML document shall:

- Validate against the Curriculum Inventory XML Schema available at: <http://ns.medbiq.org/curriculuminventory/v10/curriculuminventory.xsd>
- Conform to any additional requirements stated in this specification.
- Optionally include elements not defined in this document only in permitted areas and only if those elements are namespace qualified.

6.0 Common Data Types

Most of the elements and attributes in MedBiquitous XML documents use the data types defined by the World Wide Web Consortium (W3C) XML schema definition [XSD]. In some cases, MedBiquitous creates its own datatypes as part of its best practices or to meet a specific requirement. Commonly used datatypes are defined in the common.xsd file. For more information about common datatypes, see: <http://www.medbiq.org/sites/default/files/CommonSpecifications.pdf>

6.1 Identifying Data Through XPath

XPath is a language for finding information in an XML document. XPath is used to navigate through elements and attributes in an XML document. It is a W3C Standard.

The MedBiquitous Curriculum Inventory uses XPath to point to data and resources in a single XML report.

XPath expressions use the following construction:

<code>/SomeElement/SomeSubElement</code>	Selects all SomeSubElements that are sub-elements of SomeElement.
<code>/SomeElement/SomeSubElement[@test='x']</code>	Selects all SomeSubElements that have an attribute named test with a value of 'x' that are sub-elements of SomeElement.
<code>/SomeElement/SomeSubElement/text ()</code>	Selects all element content (text) in all SomeSubElements that are sub-elements of SomeElement.

Example:

```
/CurriculumInventory/Events/Event[@id='123']
```

This example provides a reference to the Event with an id of 123.

7.0 Introduction to Curriculum Inventory

This document describes the MedBiquitous Curriculum Inventory Schema in detail. It is intended for use by anyone who wants to create or implement interoperable tools based on this specification.

The objective of the Curriculum Inventory Schema is to provide a data structure that allows one to represent a health professions curriculum in a standard format. This structure then enables the exchange and aggregation of curriculum data across the continuum of professional education and training.

The standard allows extensions so that data beyond the core set identified in this document may be communicated to other organizations. This specification is intended to work in concert with other specifications.

The development of health professions education curricula is a time consuming and complex task. Educational reform efforts are encouraging the development of non-traditional curricula that use novel and innovative methods for teaching and assessment. In many institutions there is a push towards competency-based learning as the cornerstone of curriculum development efforts. In addition, health professions reform has mandated that new content or competencies be integrated into the curriculum, including cultural competencies, patient safety, team-based learning, systems-based practice, etc. To facilitate broad curricular reform, it is necessary to enable the aggregation of curriculum data for research and benchmarking purposes.

8.0 Other Standards, Specifications, or Schemas Referenced

This standard references the following standards, specifications, or schemas. The informative references here, which describe how these references are used, link to formal references appearing later in this document.

- MEDBIQ PP.10.1-2008, Healthcare Professional Profile [[Professional Profile](#)]
The Professional Profile provides a common format for information describing the individual healthcare professional, including name, address, institution, licensure, certification, and more.
- MEDBIQ LO.10.1-2008, Healthcare Learning Object Metadata [[Healthcare LOM](#)]
Healthcare LOM extends the IEEE LOM standard and provides a format for describing healthcare learning resources and activities. Vocabularies and datatypes from Healthcare LOM are used in the Curriculum Inventory.
- MedBiquitous Competency Framework [[Competency Framework](#)]
Competency Framework provides a way of specifying the hierarchical and non-hierarchical relationships among competencies, learning objectives, learning outcomes, etc.
- MedBiquitous Competency Object [[Competency Object](#)]
Competency Object provides a common format for representing competencies, learning objectives, learning outcomes, etc.

9.0 Curriculum Inventory Schema

The following sections explain the Curriculum Inventory Schema grammar. Values in **bold** under XML Tags column indicate that the element has sub-elements.

All the elements having sub-elements will be defined in separate sections. All elements without sub-elements will be defined within the appropriate element sections that use them.

9.1 CurriculumInventory

CurriculumInventory is the root element. It contains sub elements that provide data on a health professions curriculum for a specific period of time.

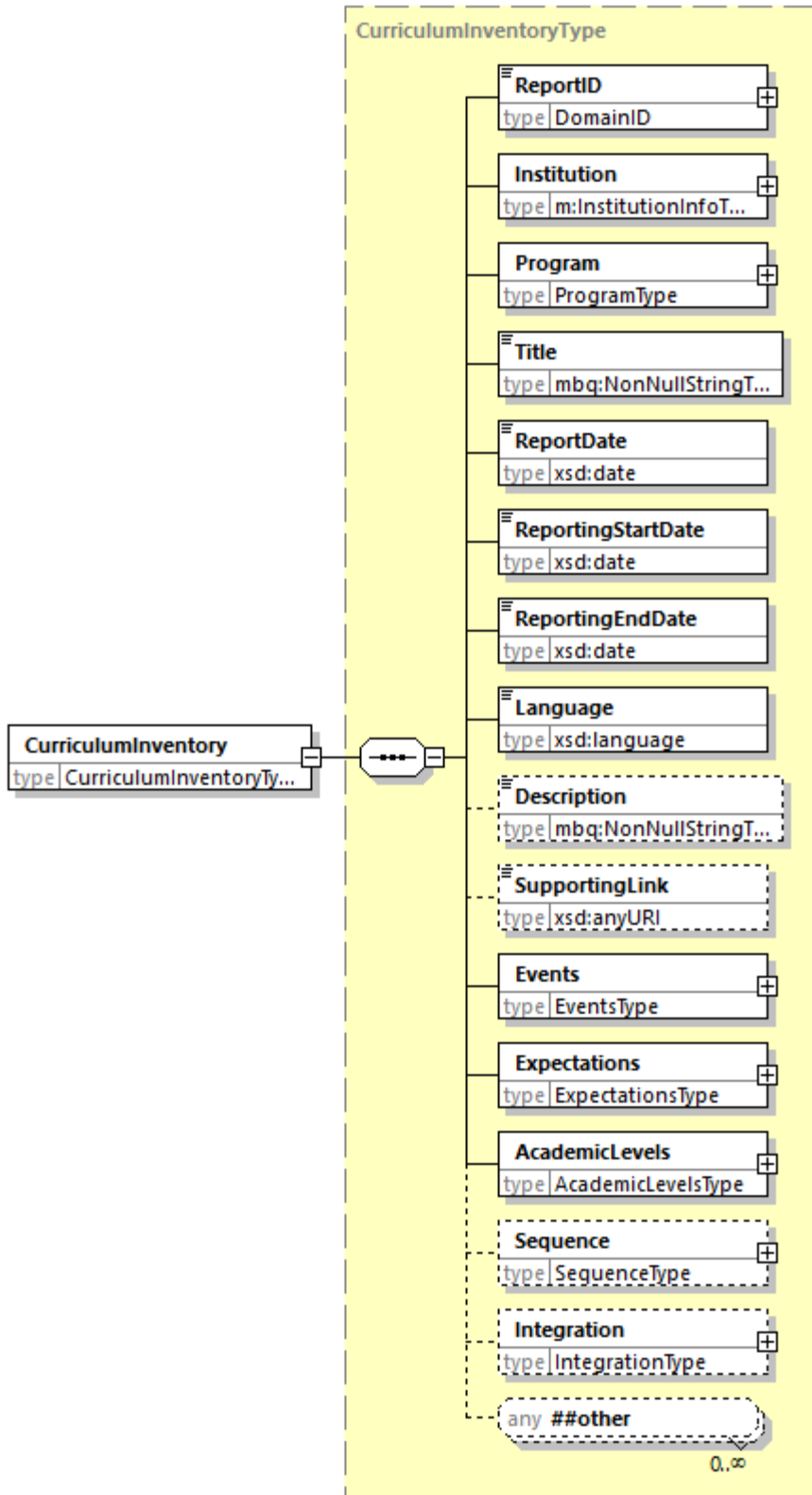

Generated by XMLSpy

www.altova.com

CurriculumInventory Element Information

Element	Description	Required	Multiplicity	Datatype
CurriculumInventory	CurriculumInventory is the root element. It contains sub elements that provide data on a health professions curriculum for a specific period of time.	Required	1	Container
ReportID	<p>A unique identifier for this Curriculum Inventory. ReportID has the following attribute:</p> <p><i>domain</i></p> <p>Defines the organization that is the source of the unique identifier. <i>domain</i> has the following format:</p> <p><i>idd:domainname:localidentifier</i></p> <p>Where:</p> <p><i>domainname</i> is internet domain name that is a valid URN authority (see RFC 3986 - URI) and is owned by the organization issuing the unique ID. and</p> <p><i>localidentifier</i> is a local identifier for the type of unique ID.</p> <p>For example:</p> <p><code>idd:ucsf.edu:somreport</code></p>	Required	1	Non-null string
Institution	<p>Institution contains the name, identifier, and address of the institution whose curriculum is described.</p> <p>Institution uses the InstitutionInfoType from the MedBiquitous Healthcare Professional Profile.</p>	Required	1	Container For more information, see MEDBIQ 10.1-2008 Healthcare Professional Profile [Professional Profile] .
Program	Program contains the name and identifier of the educational program that the Curriculum Inventory describes.	Required	1	Container
Title	The title of the Curriculum Inventory.	Required	1	Non-null string
ReportDate	The date the report was created.	Required	1	Date

Element	Description	Required	Multiplicity	Datatype
ReportingStartDate	The first day of the reporting period that this Curriculum Inventory covers.	Required	1	Date
ReportingEndDate	The last day of the reporting period that this Curriculum Inventory covers.	Required	1	Date
Language	The default language of the report contents. The language element does not apply to elements with enumerated values, such as EducationalContext and ClerkshipModel. In addition, the language element may not apply to other elements where use of a vocabulary is recommended (i.e. Profession, Specialty, InstructionalMethod, AssessmentMethod) or where another language is specified. For example, en-US indicates US English.	Required	1	Language
Description	A free text description of the curriculum.	Optional	1	Non-null string
SupportingLink	A link to supporting information, such as a pictorial representation of the curriculum or a document explaining the rationale behind the curriculum structure. The link must be a URN or URL. For example: http://www.example.edu/curriculum.pdf	Optional	1	anyURI
Events	Events contains information about the education and assessment events that comprise the curriculum. For more information, see section Events.	Required	1	Container
Expectations	Expectations contains subelements that describe the competencies, learning objectives, and learning outcomes implemented in a curriculum and how they are organized. For more information, see section Expectations.	Required	1	Container
AcademicLevels	AcademicLevels contains subelements that describe information about the academic levels defined for this curriculum. For more information, see section AcademicLevels.	Required	1	Container
Sequence	Sequence contains subelements that describe information about how the curriculum is organized over a period of time. For more information, see section Sequence.	Optional	0 or 1	Container

Element	Description	Required	Multiplicity	Datatype
Integration	Integration contains subelements that describe how a curriculum is integrated. For more information, see section Integration.	Optional	0 or 1	Container
Elements from other namespaces	CurriculumInventory may include elements from other namespaces provided those elements are namespace qualified.	Optional	0 or more	any

Example:

```

<CurriculumInventory>
  <ReportID>12345</ReportID>
  <Institution>
    <m:InstitutionName>
      Johns Hopkins University School of Medicine
    </m:InstitutionName>
    <m:InstitutionID domain="aamc.org">133</m:InstitutionID>
    <m:Address>
      <a:City>Baltimore</a:City>
      <a:StateOrProvince>MD</a:StateOrProvince>
      <a:Country>
        <a:CountryCode>US</a:CountryCode>
      </a:Country>
    </m:Address>
  </Institution>
  <Program>
    <ProgramName>M.D.</ProgramName>
    <ProgramID domain="idd:aamc.org:cip">5678</ProgramID>
  </Program>
  <Title>Johns Hopkins School of Medicine Genes to Society Curriculum
  2010-2011</Title>
  <ReportDate>2011-07-01</ReportDate>
  <ReportingStartDate>2010-07-01</ReportingStartDate>
  <ReportingEndDate>2011-06-30</ReportingEndDate>
  <Language>en-us</Language>
  <Description>The Genes to Society curriculum reframes the context of
  health and illness more broadly, to encourage students to explore the
  biologic properties of a patient's health within a larger, integrated
  system including social, cultural, psychological, and environmental
  variables.</Description>
  <SupportingLink>http://www.hopkinsmedicine.org/crc/</SupportingLink>
  <Events>
    <Event>
      . . .
    </Event>
    <Event>
      . . .
    </Event>
  </Events>
  <Expectations>
    <CompetencyObject>
      . . .
    </CompetencyObject>
    <CompetencyObject>
      . . .
    </CompetencyObject>
  </Expectations>
  <AcademicLevels>

```

```

. . .
</AcademicLevels>
<Sequence>
  <SequenceBlock>
    . . .
  </SequenceBlock>
  <SequenceBlock>
    . . .
  </SequenceBlock>
</Sequence>
</Integration>
  <IntegrationBlock>
    . . .
  </IntegrationBlock>
  <IntegrationBlock>
    . . .
  </IntegrationBlock>
</Integration>
</CurriculumInventory>

```

9.2 Program

Program is a subelement of CurriculumInventory. It contains sub elements that describe the name and identifier of the educational program that the Curriculum Inventory describes.

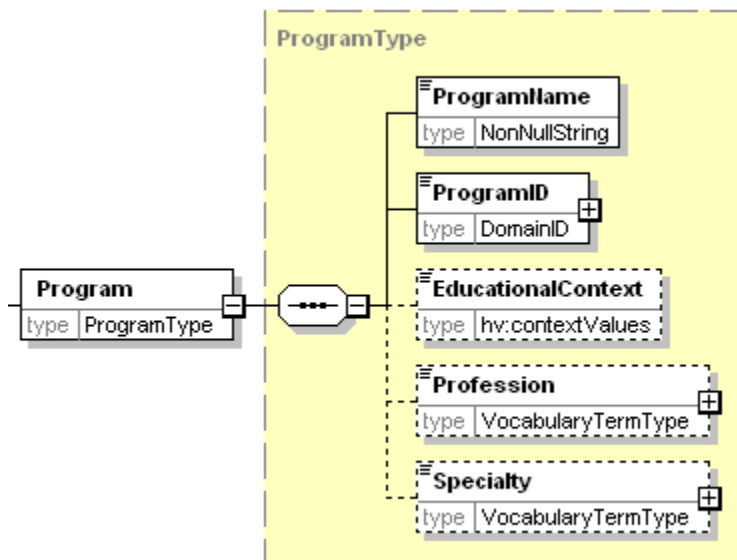

Program Element Information

Element	Description	Required	Multiplicity	Datatype
Program	Program contains the name and identifier of the educational program that the Curriculum Inventory describes.	Required	1	Container
ProgramName	The name of the educational program. In many cases, this is the degree offered, such as M.D.	Required	1	Non-null string
ProgramID	<p>A unique identifier for this educational program. ProgramID has the following attribute:</p> <p><i>domain</i></p> <p>Defines the organization that is the source of the unique identifier. <i>domain</i> has the following format:</p> <p><code>idd:domainname:localidentifier</code></p> <p>Where:</p> <p><i>domainname</i> is an internet domain name that is a valid URN authority (see RFC 3986 - URI) and is owned by the organization issuing the unique ID. and</p> <p><i>localidentifier</i> is a local identifier for the type of unique ID.</p> <p>For example:</p> <p><code>idd:aamc.org:cip</code></p>	Required	1	Non-null string

Element	Description	Required	Multiplicity	Datatype
EducationalContext	<p>The educational environment for which the learning activity is intended. Values come from the Healthcare LOM vocabulary for educational context. Valid values are:</p> <ul style="list-style-type: none"> • patient education • caregiver education • primary education • secondary education • vocational training • undergraduate education • undergraduate professional education • graduate professional education • continuing professional development 	Optional	0 or 1	Restricted See Description for details.
Profession	<p>The health profession for which the curriculum is intended or which the curriculum is intended to produce. For example, physician, registered nurse, etc. See MEDBIQ LO.10.1-2008 Healthcare Learning Object Metadata Specifications and Description Document Appendix 2 for a hierarchical list of recommended values [Healthcare LOM].</p> <p>Profession has the following attributes:</p> <p><i>source</i> The taxonomy or vocabulary serving as the source of the profession. For Healthcare LOM version 1, use HEALTHCARE_LOMv1</p> <p><i>sourceID</i> The unique identifier assigned to this taxonomic reference within the taxonomy or vocabulary. To view identifiers for the Healthcare LOM list of professions, see: http://www.medbiq.org/hlomv1/profession</p>	Optional	0 or 1	Non-null string

Element	Description	Required	Multiplicity	Datatype
Specialty	<p>The healthcare specialty within a profession for which the curriculum is intended or which the curriculum is intended to produce. For example, cardiology. See MEDBIQ LO.10.1-2008 Healthcare Learning Object Metadata Specifications and Description Document Appendix 2 for a hierarchical list of recommended values [Healthcare LOM].</p> <p>Specialty has the following optional attributes:</p> <p><i>source</i> The taxonomy or vocabulary serving as the source of the specialty. For Healthcare LOM version 1, use HEALTHCARE_LOMv1</p> <p><i>sourceID</i> The unique identifier assigned to this taxonomic reference within the taxonomy or vocabulary. The view identifiers for the Healthcare LOM list of specialties, see: http://www.medbiq.org/hlomv1/specialty</p>	Optional	0 or 1	Non-null string

Example:

```
<Program>
  <ProgramName>M.D.</ProgramName>
  <ProgramID domain="idd:aamc.org:program">5678</ProgramID>
</Program>
```

9.3 Events

Events is a sub element of CurriculumInventory. It contains sub elements that describe information about the education and assessment events that comprise the curriculum.

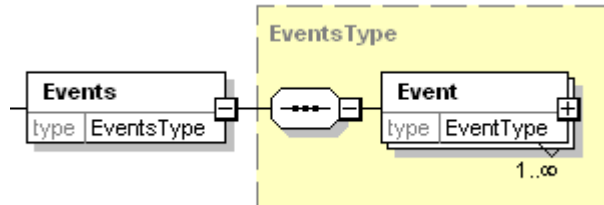

Events Element Information

Element	Description	Required	Multiplicity	Datatype
Events	Events contains sub elements that describe information about the education and assessment events that comprise the curriculum	Required	1	Container
Event	Event contains subelements that describe a single education or assessment event. Examples of events include: lecture, problem-based learning activity, virtual patient activity, Simulation activity, seminar, lab, and bedside learning activity, to name a few. For more information, see section Event.	Required	1 or more	Container

Example:

```

<Events>
  <Event>
    . . .
  </Event>
  <Event>
    . . .
  </Event>
</Events>

```

9.3.1 Event

Event contains subelements that describe a single education or assessment event. Examples of events include: lecture, problem-based learning activity, virtual patient activity, Simulation activity, seminar, lab, and bedside learning activity, to name a few. Events can be combined to form a sequence block within a curriculum. Events may reference learning objectives, competencies, or learning outcomes captured in expectations, as well as curricular themes, known as integration blocks. A single event may occur in multiple sequence blocks within the curriculum.

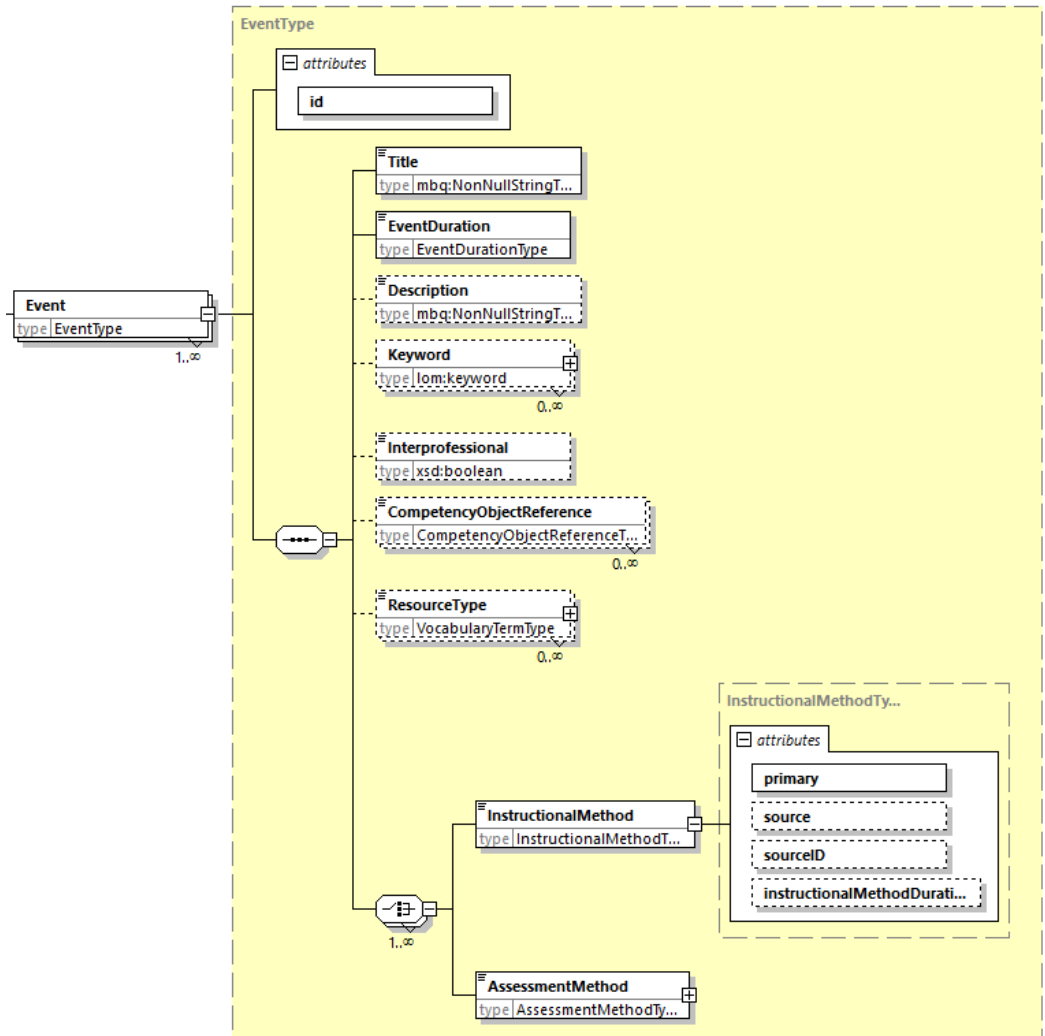

Generated by XMLSpy

www.altova.com

Event Element Information

Element	Description	Required	Multiplicity	Datatype
Event	Events contains sub elements that describe information about the education and assessment events that comprise the curriculum. Event has the following attributes: <i>id</i> A unique identifier for this event. The identifier must be unique within the scope of this report. Use of the <i>id</i> attribute is required.	Required	1	Container
Title	A title for this education or assessment event.	Required	1	Non-null string
EventDuration	The duration of the event in hours and/or minutes. For example, PT20H indicates 20 hours.	Required	1	Duration (restricted to hours and/or minutes)
Description	A free text description of the education or assessment event.	Optional	0 or 1	Non-null string
Keyword	An important concept or topic related to the event. Keyword uses the keyword type and custom attributes from Healthcare Learning Object Metadata.	Optional	0 or more	For more information see MEDBIQ LO.10.1-2008 [Healthcare LOM].
Interprofessional	An indicator as to whether or not this event is designed to engage students of different health professions as teams. The default value is false.	Optional	0 or 1	Boolean
CompetencyObjectReference	A reference to the unique id for a learning objective, competency, learning outcome, (all of which are known as competency objects) associated with this event. CompetencyObjectReference has the following format: <code>/CurriculumInventory/Expectations/CompetencyObject [lom:lom/lom:general/lom:identifier/lom:entry='X']</code> All in one line, where X is the id of a Competency Object in this Curriculum Inventory.	Optional	0 or more	Restricted (to conformant XPath) See section 4.2 Identifying Data through XPath for more information

Element	Description	Required	Multiplicity	Datatype
ResourceType	<p>A type of resource used in this event. A recommended list is available as part of the Curriculum Inventory Standardized Instructional and Assessment Methods and Resource Types [Vocabularies].</p> <p>Resource has the following attributes:</p> <p><i>source</i> The taxonomy or vocabulary serving as the source of the resource type.</p> <p><i>sourceID</i> the unique identifier assigned to this taxonomic reference within the taxonomy or vocabulary</p>	Optional	0 or more	Non-null string

Element	Description	Required	Multiplicity	Datatype
InstructionalMethod	<p>An instructional method used in this event. It is strongly recommended that communities using the Curriculum Inventory to share information use an agreed upon set of terms. A recommended list is available as part of the Curriculum Inventory Standardized Instructional and Assessment Methods and Resource Types [Vocabularies].</p> <p>InstructionalMethod has the following attributes:</p> <p><i>primary</i> Indicates whether or not this instructional method is the primary instructional method of the event. Use of the <i>primary</i> attribute is required. Valid values are true and false. One instructional method must be marked as primary for an instructional event.</p> <p><i>source</i> The taxonomy or vocabulary serving as the source of the InstructionalMethod.</p> <p><i>sourceID</i> The unique identifier assigned to this taxonomic reference within the taxonomy or vocabulary</p> <p>instructionalMethodDuration</p> <p>This attribute allows the amount of time for an instructional method to be documented using the following patterns:</p> <p style="padding-left: 40px;">"PT\d+H\d+M PT\d+H PT\d+M"</p> <p>Where H is hours, M is minutes. Time can be represented as hours and minutes (PT\d+H\d+M), hours (PT\d+H), or minutes (PT\d+M).</p>	Either Instructional Method or Assessment Method is required	0 or more	Non-null string

Element	Description	Required	Multiplicity	Datatype
AssessmentMethod	<p>An assessment method used in this event. It is strongly recommended that communities using the Curriculum Inventory to share information use an agreed upon set of terms. A recommended list is available as part of the Curriculum Inventory Standardized Instructional and Assessment Methods and Resource Types [Vocabularies].</p> <p>AssessmentMethod has the following attributes:</p> <p><i>purpose</i> Indicates whether the assessment is used for formative or summative assessment. Use of the <i>purpose</i> attribute is required. Valid values are Formative and Summative.</p> <p><i>source</i> The taxonomy or vocabulary serving as the source of the assessment method.</p> <p><i>sourceID</i> The unique identifier assigned to this taxonomic reference within the taxonomy or vocabulary</p>	Either Instructional Method or Assessment Method is required	0 or more	Non-null string

Example:

```

<Event id="E1">
  <Title>White Coat Ceremony</Title>
  <EventDuration>PT2H</EventDuration>
  <Description>First year students are given their white coats to
  mark the transition to clinical rotations. The ceremony includes
  a declaration of professional values. </Description>
  <Keyword hx:source="MeSH" hx:id="D010817">
    <hx:string>Physician-Patient Relations</hx:string>
  </Keyword>
  <Keyword hx:source="MeSH" hx:id="D012945">
    <hx:string>Social Values</hx:string>
  </Keyword>
  <Interprofessional>>false</Interprofessional>
  <CompetencyObjectReference>/CurriculumInventory/Expectations/Comp
  etencyObject[lom:lom/lom:general/lom:identifier/lom:entry='http:/
  /nosuchdomain.edu/zxcvb']</CompetencyObjectReference>
  <InstructionalMethod primary="true"
  instructionalMethodDuration="PT1H">Lecture</InstructionalMethod>
</Event>

```

9.4 Expectations

The Expectations element is the subelement of CurriculumInventory. Expectations contains subelements that describe the competencies, learning objectives, and learning outcomes implemented in a curriculum and how they are organized into competency frameworks. Expectations may be referenced from events, sequence blocks and integration blocks.

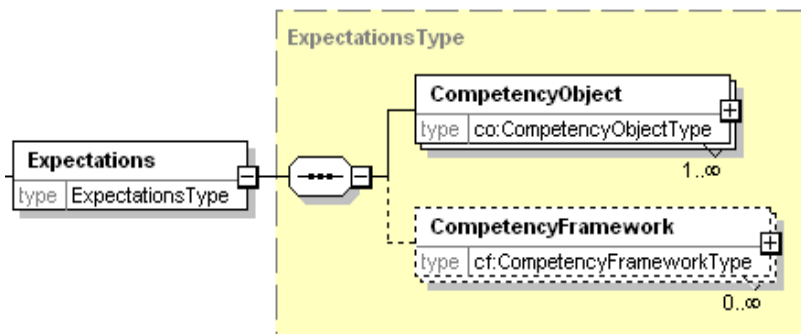

Expectations Element Information

Element	Description	Required	Multiplicity	Datatype
Expectations	Expectations contains subelements that describe the competencies, learning objectives, learning outcomes, milestones, and performance levels implemented in a curriculum and how they are organized.	Required	1	Container
CompetencyObject	CompetencyObject contains sub elements that define and uniquely identify a competency, learning objective, learning outcome, etc. The CompetencyObject datatype is defined in the Competency Object specification.	Required	1 or more	For more information see the MedBiquitous Competency Object Specifications and Description Document [Competency Object].
CompetencyFramework	CompetencyFramework contains sub elements that describes a set of related competency definitions and their relationships. The Competency Framework datatype is defined in the Competency Framework specification.	Optional	0 or more	For more information see MedBiquitous Competency Framework Specifications and Description Document [Competency Framework].

Example:

```

<Expectations>
  <CompetencyObject>
    <lom:lom>
      <lom:general>
        <lom:identifier>
          <lom:catalog>URI</lom:catalog>
          <lom:entry>http://nosuchdomain.edu/zxcvb</lom:entry>
        </lom:identifier>
        <lom:title>
          <lom:string>Professionalism</lom:string>
        </lom:title>
      </lom:general>
    </lom:lom>
  </CompetencyObject>
  <CompetencyObject>
    . . .
  </CompetencyObject>
  <CompetencyObject>
    . . .
  </CompetencyObject>
  <CompetencyObject>
    . . .
  </CompetencyObject>
  <CompetencyFramework>
    <lom:lom>
      <lom:general>
        <lom:identifier>
          <lom:catalog>URI</lom:catalog>
          <lom:entry>http://nosuchdomain.edu/framework</lom:entry>
        </lom:identifier>
      </lom:general>
    </lom:lom>
    <cf:Includes>
      <cf:Catalog>URI</cf:Catalog>
      <cf:Entry>http://nosuchdomain.edu/zxcvb</cf:Entry>
    </cf:Includes>
    <cf:Includes>
      . . .
    </cf:Includes>
    <cf:Includes>
      . . .
    </cf:Includes>
  </CompetencyFramework>
</Expectations>

```

9.5 AcademicLevels

AcademicLevels is the subelement of Curriculum Inventory that defines the levels within an academic program. Many programs use academic years as levels within their curriculum; others use phases or stages of varying lengths.

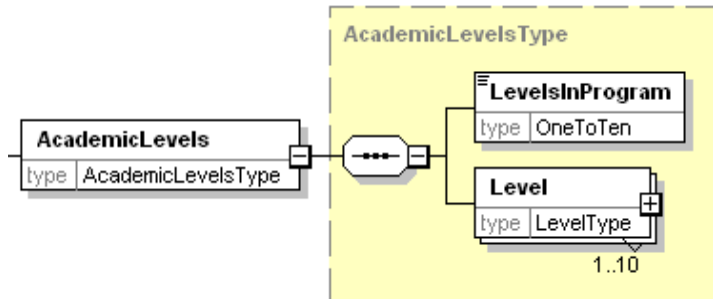

AcademicLevels Element Information

Element	Description	Required	Multiplicity	Datatype
AcademicLevels	AcademicLevels contains subelements that describe information about the academic levels defined for this curriculum.	Required	1	Container
LevelsInProgram	The number of levels in the academic program. LevelsInProgram must be a number from 1 to 10.	Required	1	Restricted See Description for details.
Level	Level provides more descriptive information about a single level of the academic program. For more information, see section Level.	Required	1 to 10	Container

Example:

```

<AcademicLevels>
  <LevelsInProgram>4</LevelsInProgram>
  <Level number="1">
    <Label>Year 1</Label>
    <Description>Preclinical</Description>
  </Level>
  <Level number="2">
    <Label>Year 2</Label>
    <Description>Preclinical</Description>
  </Level>
  <Level number="3">
    <Label>Year 3</Label>
    <Description>Clinical</Description>
  </Level>
  <Level number="4">
    <Label>Year 4</Label>
    <Description>Clinical</Description>
  </Level>
</AcademicLevels>

```

9.6 Level

Level provides more descriptive information about a single level of the academic program, such as a single academic year, or a single phase of the curriculum.

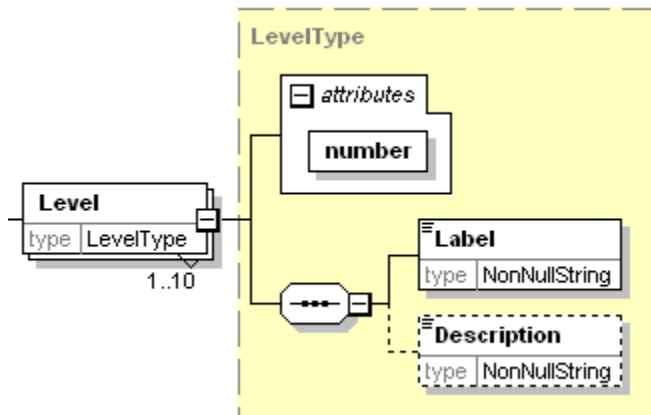

Level Element Information

Element	Description	Required	Multiplicity	Datatype
Level	<p>Level provides more descriptive information about a single level of the academic program. The number of levels specified must correspond to the number provided in LevelsInProgram. For example, if LevelsInProgram has a value of 4, there must be 4 instances of the Level element, each describing one level of the academic program.</p> <p>Level has the following attribute.</p> <p><i>number</i> A number associated with this academic level, indicating the order of this level in relation to others. Level 1 is the first in a sequence. Use of the <i>number</i> attribute is required.</p> <p><i>number</i> must be a number from 1 to 10. Each level number should be unique and together the level numbers should create a sequential order.</p>	Required	1 to 10	Container
Label	A short descriptive title for this academic level. For example, First Year.	Required	1	Non-null String
Description	A description of the academic level.	Optional	0 or 1	Non-null String

Example:

```
<Level number="1">
  <Label>Year 1</Label>
  <Description>Preclinical</Description>
</Level>
```

9.7 Sequence

Sequence is the sub element of CurriculumInventory that contains subelements that describe information about how the curriculum is organized over a period of time. The curriculum's sequence consists of a series of sequence blocks, which correspond to courses or other blocks of curricular content.

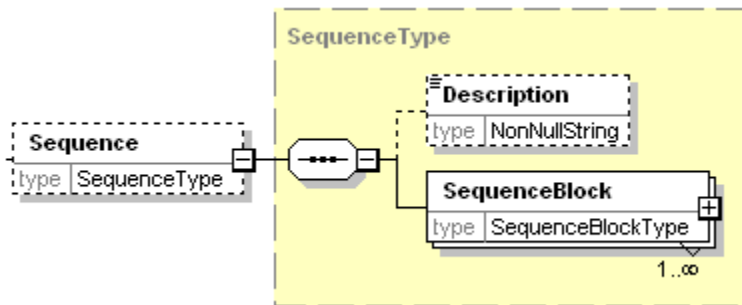

Sequence Element Information

Element	Description	Required	Multiplicity	Datatype
Sequence	Sequence contains sub elements that describe information about how the curriculum is organized over a period of time.	Optional	1	Container
Description	A description of the overall sequence of the curriculum.	Optional	0 or 1	Non-null string
SequenceBlock	Contains sub elements that define an organizational component of the curriculum, such as a year, phase, course module, etc. See section SequenceBlock for more information.	Required	1 or more	Container

Example:

```
<Sequence>
  <Description>There are 2 years of preclinical work followed by 2 years
of clinical work.</Description>
  <SequenceBlock required="true" id="asdfg">
    . . .
  </SequenceBlock>
  <SequenceBlock required="true" id="sdfgh">
    . . .
  </SequenceBlock>
</Sequence>
```

9.7.1 SequenceBlock

SequenceBlock is a sub element of Sequence that contains sub elements that define an organizational component of the curriculum, such as a year, phase, course, module, etc. Sequence blocks can be nested to show a variety of organizational methods, including an ordered set of courses within a phase of instruction, a series of electives, selectives, and parallel blocks.

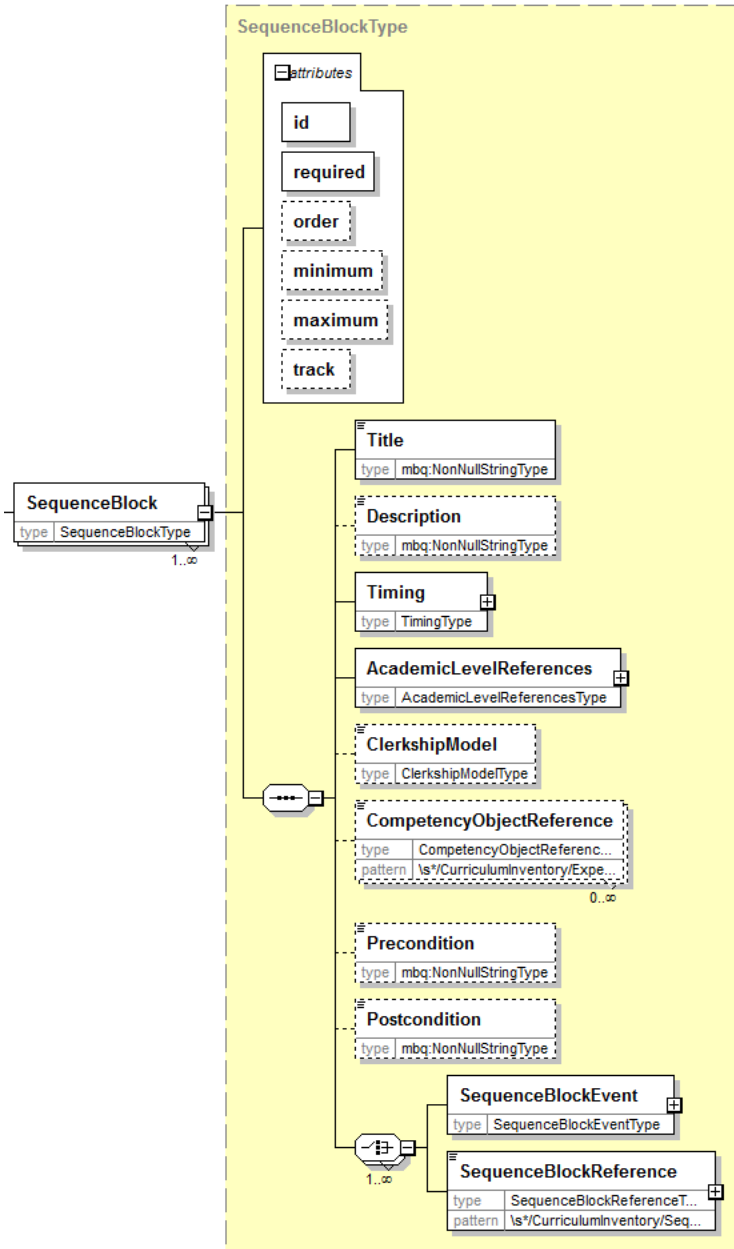

Generated by XMLSpy

www.altova.com

SequenceBlock Element Information

Element	Description	Required	Multiplicity	Datatype
SequenceBlock	<p>Contains subelements that define a component of the curriculum, such as a course, module, phase, year, etc. SequenceBlock has the following attributes:</p> <p><i>id</i> A unique identifier for this sequence block. The identifier must be unique within the scope of this report. Use of the <i>id</i> attribute is required.</p> <p><i>required</i> Indicates whether this sequence block is a required part of the curriculum. Valid values are Required, Optional, and Required In Track. Use of the <i>required</i> attribute is required.</p> <p><i>order</i> If there are nested sequence blocks, <i>order</i> indicates how the nested sequence blocks are delivered to learners. Valid values are Ordered, Unordered, and Parallel. Ordered indicates that the nested sequence blocks are delivered according to an established order. Unordered indicates that the nested sequence blocks may be delivered in any order. Parallel indicates that the nested sequence blocks occur at the same time.</p> <p><i>minimum</i> If there are nested sequence blocks, <i>minimum</i> indicates the minimum number of nested sequence blocks that a learner must take. For optional courses/electives, this value is 0. If the sequence block indicates selective courses, indicate the minimum number of selectives.</p> <p><i>maximum</i> If there are nested sequence blocks, <i>maximum</i> indicates the maximum number of nested sequence blocks that a learner can take.</p> <p><i>track</i> Indicates whether this sequence block is a track within the curriculum. Valid values are true and false; the default value is false.</p>	Required	1 or more	Container

Element	Description	Required	Multiplicity	Datatype
Title	The title of the sequence block.	Required	1	Non-null string
Description	A description of the sequence block.	Optional	0 or 1	Non-null string
Timing	Timing contains subelements that indicate either the start and end dates of the sequence block or the duration of the sequence block, or both the start and end dates and the duration of the sequence block. For more information, see section Timing.	Required	1	Container
AcademicLevelReferences	AcademicLevelReferences contains subelements that indicate the starting and ending educational levels for this sequence block.	Required	1	Container
ClerkshipModel	If the sequence block represents a clerkship, clerkship model may be used to indicate the type of clerkship. Valid values are: integrated, rotation.	Optional	0 or 1	Restricted See Description for details.
CompetencyObjectReference	A reference to the unique id for a learning objective, competency, learning outcome, (all of which are known as competency objects) associated with this sequence block. CompetencyObjectReference has the following format: <pre> /CurriculumInventory/Expectations/CompetencyObject [lom:lom/lom:general/lom:identifier/lom:entry='X'] </pre> All in one line, where X is the id of a Competency Object in this Curriculum Inventory.	Optional	0 or more	Restricted (to conformant XPath) See section 4.2 Identifying Data through XPath for more information
Precondition	Describes preconditions that must be met for a learner to take this course.	Optional	0 or 1	NonNull String
Postcondition	Describes how the curriculum changes depending on the learner's performance in the sequence block.	Optional	0 or 1	NonNull String
SequenceBlockEvent	Contains sub elements that identify and describe an education or assessment event included in the sequence block. For more information, see section SequenceBlockEvent.	Either SequenceBlock Event or SequenceBlock	0 or more	Container

Element	Description	Required	Multiplicity	Datatype
		Reference is required.		
SequenceBlockReference	<p>A reference to a nested sequence block. SequenceBlockReference has the following format:</p> <pre>/CurriculumInventory/Sequence/SequenceBlock[@id='X']</pre> <p>All in one line, where <i>X</i> is the id of a sequence block in this Curriculum Inventory.</p> <p>SequenceBlockReference has the following attribute:</p> <p><i>order</i></p> <p>A positive integer indicating the order of this sequence block in relation to other nested sequence blocks. The <i>order</i> attribute must be used if the <i>order</i> attribute of the parent sequence block has a value of ordered.</p>	Either SequenceBlock Event or SequenceBlock Reference is required.	0 or more	Restricted (to conformant XPath) See section 4.2 Identifying Data through XPath for more information

Example:

```

<SequenceBlock id="c" required="Required">
  <Title>Year 1</Title>
  <Timing>
    <Duration>P12M</Duration>
  </Timing>

  <Level>/CurriculumInventory/AcademicLevels/Level[@number='1']</Level>
  <CompetencyObjectReference>
    /CurriculumInventory/Expectations/CompetencyObject[lom:lom/lom:general/lom:
    identifier/lom:entry='http://nosuchdomain.edu/zxcvb']
  </CompetencyObjectReference>
  <SequenceBlockEvent required="true">

    <EventReference>/CurriculumInventory/Events/Event[@id='E1']</EventRefer
    ence>
    </SequenceBlockEvent>
    <SequenceBlockEvent required="true">

      <EventReference>/CurriculumInventory/Events/Event[@id='E2']</EventRefer
      ence>
      </SequenceBlockEvent>
    </SequenceBlockEvent>
  </SequenceBlock>

```

9.7.2 Timing

Timing is a subelement of SequenceBlock that contains subelements indicating either the start and end dates of the sequence block or the duration of the sequence block. Alternately Timing may indicate the start and end dates and the duration of the sequence block. If a sequence block is representing a course that occurs multiple times (such as clerkships), indicate the duration and omit the dates. If only duration is indicated, the parent sequence block should indicate dates that show the time frame in which the child sequence blocks may occur.

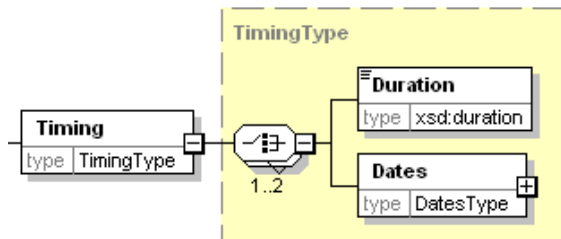

Timing Element Information

Element	Description	Required	Multiplicity	Datatype
Timing	Timing contains subelements that indicate either the start and end dates of the sequence block or the duration of the sequence block, or both the start and end dates and the duration of the sequence block.	Required	1	Container
Duration	The duration of the sequence block.	Either Duration or Dates is required. Alternately both Duration and Dates can be provided.	0 or 1	Duration
Dates	Dates contains subelements that identify the start date and end date for this sequence block. See section Dates for more information.	Either Duration or Dates is required. Alternately both Duration and Dates can be provided.	0 or 1	Container

Example:

```
<Timing>
  <Duration>P12M</Duration>
</Timing>
```

9.7.3 AcademicLevelReferences

AcademicLevelReferences contains subelements that indicate the starting and ending educational levels for this sequence block. It also indicates if the sequence block is longitudinal or has flexible scheduling, in other words, that a sequence block may occur in one of two or more academic levels.

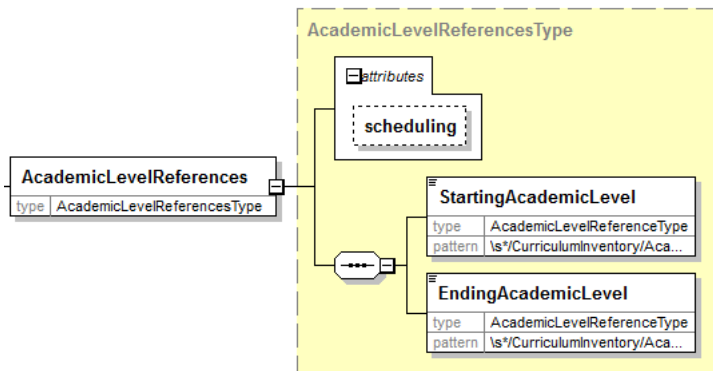

AcademicLevelReferences Element Information

Element	Description	Required	Multiplicity	Datatype
AcademicLevelReferences	<p>AcademicLevelReferences contains subelements that indicate the starting and ending educational levels for this sequence block. AcademicLevelReferences has the following attribute:</p> <p><i>scheduling</i> The scheduling attribute indicates if the sequence block is longitudinal (ie it spans multiple academic levels) or flexible (ie it may occur in one of two or more academic levels). Valid values are longitudinal and flexible. If the sequence block is neither longitudinal or flexible, omit this attribute.</p>	Required	1	Container
StartingAcademicLevel	<p>A reference to the academic level in which the sequence block begins or the first academic level in which it may occur. For schools using academic years as the basis for progress through the curriculum, StartingAcademicLevel corresponds to the academic year in which the sequence block begins or the first academic year in which it may occur. StartingAcademicLevel has the following format:</p> <p><code>/CurriculumInventory/AcademicLevels/Level[@number='X']</code></p> <p>All in one line, where X is the number 1 through 10 corresponding to an academic level defined in this Curriculum Inventory.</p>	Required	1	<p>Restricted (to conformant XPath)</p> <p>See section 4.2 Identifying Data through XPath for more information</p>
EndingAcademicLevel	<p>A reference to the academic level in which the sequence block ends or the last academic level in which it may occur. For schools using academic years as the basis for progress through the curriculum, EndingAcademicLevel corresponds to the academic year in which the sequence block ends or the last academic year in which it may occur. EndingAcademicLevel has the following format:</p> <p><code>/CurriculumInventory/AcademicLevels/Level[@number='X']</code></p> <p>All in one line, where X is the number 1 through 10 corresponding to an academic level defined in this Curriculum Inventory.</p>	Required	1	<p>Restricted (to conformant XPath)</p> <p>See section 4.2 Identifying Data through XPath for more information</p>

9.7.4 Dates

Dates is a subelement of Timing that identifies the start date and end date for a sequence block.

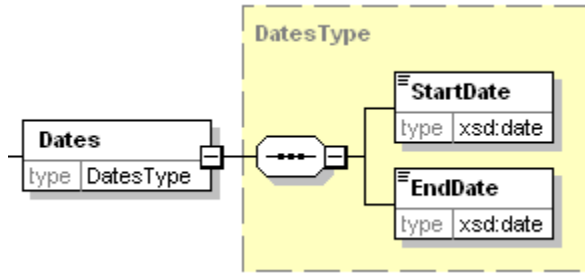

Dates Element Information

Element	Description	Required	Multiplicity	Datatype
Dates	Dates contains subelements that identify the start date and end date for this sequence block.	Either Duration or Dates is required. Alternately both Duration and Dates can be provided.	0 or 1	Container
StartDate	The date the sequence block began.	Required	1	Date
EndDate	The date the sequence block ended.	Required	1	Date

Example:

```
<Dates>
  <StartDate>2010-07-01</StartDate>
  <EndDate>2011-06-30</EndDate>
</Dates>
```

9.7.5 SequenceBlockEvent

SequenceBlockEvent contains sub elements that identify and describe an education or assessment event included in the sequence block. A sequence block may contain several events. If a sequence block contains nested sequence blocks to reflect the structure of the curriculum, it is not necessary for parent sequence blocks to contain events, although they may.

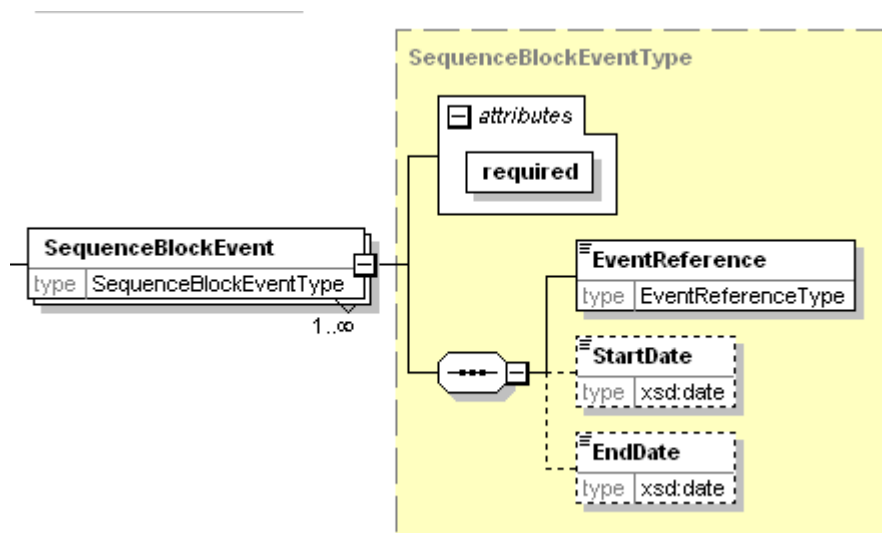

SequenceBlockEvent Element Information

Element	Description	Required	Multiplicity	Datatype
SequenceBlockEvent	<p>Contains sub elements that identify and describe an event that occurs within the sequence block.</p> <p>SequenceBlockEvent has the following attribute:</p> <p><i>required</i></p> <p>Indicates whether this event is a required part of the sequence block. The <i>required</i> attribute uses the Boolean datatype; valid values are true and false. Use of the <i>required</i> attribute is required.</p>	Optional	0 or more	Container
EventReference	<p>References the identifier, in the form of an XPath, of an event that occurs in this sequence block. EventReference has the following format:</p> <p><code>/CurriculumInventory/Events/Event[@id = 'x']</code></p> <p>All in one line, where X is the id of an event in this Curriculum Inventory.</p>	Required	1	Restricted (to conformant XPath) See section 4.2 Identifying Data through XPath for more information
StartDate	The date the event began.	Optional	1	Date
EndDate	The date the event ended or ends.	Optional	1	Date

Example:

```

<SequenceBlockEvent required="true">
  <EventReference>/CurriculumInventory/Events/Event[@id='34567']</EventReference>
  <StartDate>2011-08-15</StartDate>
  <EndDate>2011-08-15</EndDate>
</SequenceBlockEvent>

```

9.8 Integration

Integration contains subelements that describe how a curriculum is integrated. In many cases curricula are structured around organ systems or other organizing concepts, and within that context, content related to a specific topic, discipline, or theme is incorporated. For example, a course on the cardiovascular system may contain content related to themes of anatomy, pharmacology, etc.

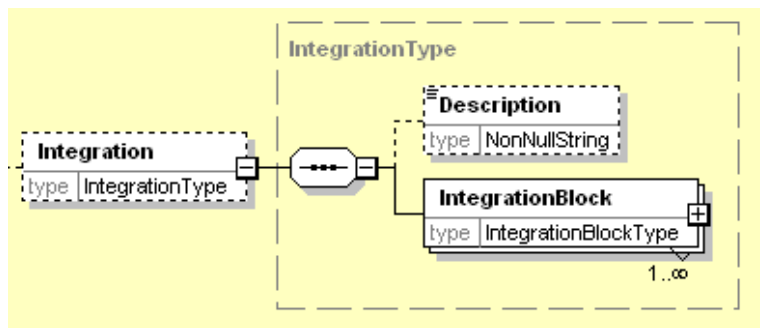

Generated by XMLSpy

www.altova.com

Integration Element Information

Element	Description	Required	Multiplicity	Datatype
Integration	Integration contains sub elements that describe how a curriculum is integrated.	Optional	1	Container
Description	A description of the approach to integrating the curriculum.	Optional	0 or 1	Non-null string
IntegrationBlock	Contains sub elements that define an integrating concept for this curriculum, such as a theme. See section IntegrationBlock for more information.	Required	1 or more	Container

Example:

```

<Integration>
  <Description>We have themes woven throughout the
curriculum</Description>
  <IntegrationBlock id="8765">
    .
    .
  </IntegrationBlock>
  <IntegrationBlock id="7654">
    .
    .
  </IntegrationBlock>
</Integration>

```

9.8.1 IntegrationBlock

IntegrationBlock contains subelements that define an integrating concept for this curriculum. Many curricula have several integrating concepts, or themes, that apply to many courses, competencies, objectives, and events.

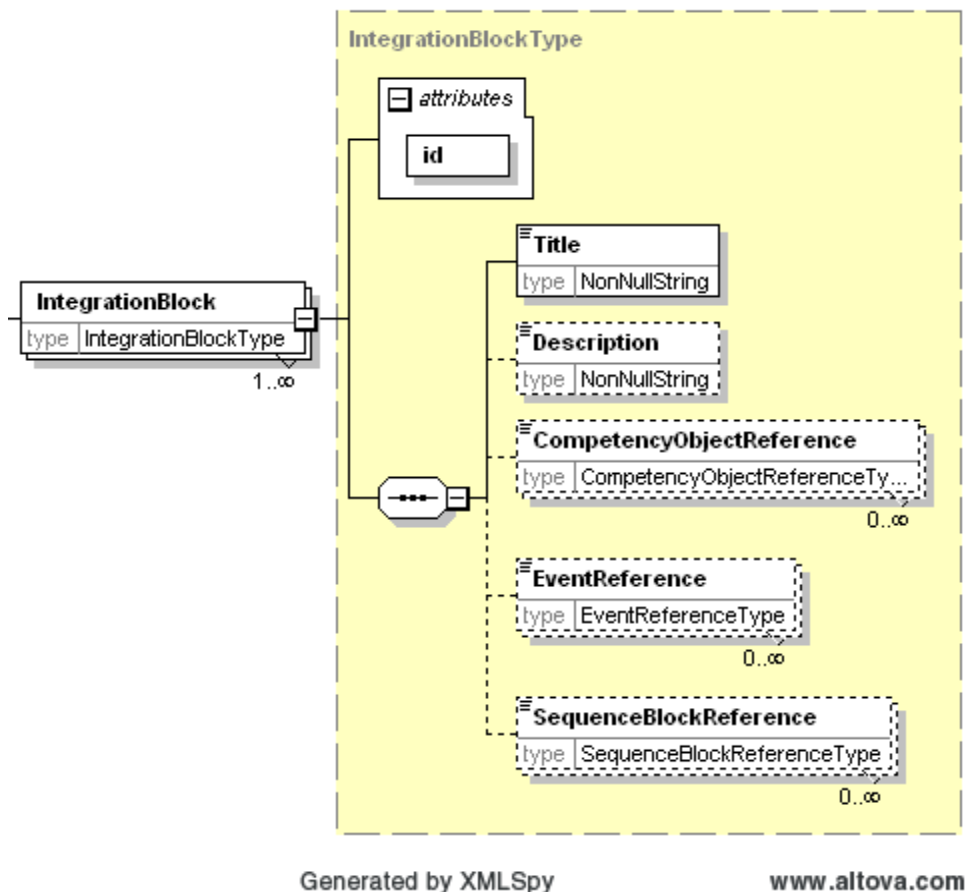

IntegrationBlock Element Information

Element	Description	Required	Multiplicity	Datatype
IntegrationBlock	Contains sub elements that define an integrating concept for this curriculum, such as a theme. IntegrationBlock has the following attribute: <i>id</i> A unique identifier for this integration block. The identifier must be unique within the scope of this report. Use of the <i>id</i> attribute is required.	Required	1 or more	Container
Title	The title of the integration block. For example, Rural Health.	Required	1	Non-null string
Description	A description of the integrating concept.	Optional	0 or 1	Non-null string
CompetencyObjectReference	A reference to the unique id for a learning objective, competency, learning outcome, (all of which are known as competency objects) associated with this integration block. CompetencyObjectReference has the following format: <code>/CurriculumInventory/Expectations/CompetencyObject [lom:lom/lom:general/lom:identifier/lom:entry='X']</code> All in one line, where X is the id of a Competency Object in this Curriculum Inventory.	Optional	0 or more	Restricted (to conformant XPath) See section 4.2 Identifying Data through XPath for more information
EventReference	A reference to an event associated with this integration block. EventReference has the following format: <code>/CurriculumInventory/Events/Event [@id='X']</code> All in one line, where X is the id of an event in this Curriculum Inventory.	Optional	0 or more	Restricted (to conformant XPath) See section 4.2 Identifying Data through XPath for more information

Element	Description	Required	Multiplicity	Datatype
SequenceBlockReference	<p>A reference to a sequence block associated with this integration block. SequenceBlockReference has the following format:</p> <pre>/CurriculumInventory/Sequence/SequenceBlock[@id='X']</pre> <p>All in one line, where X is the id of an event in this Curriculum Inventory.</p>	Optional	0 or more	<p>Restricted (to conformant XPath)</p> <p>See section 4.2 Identifying Data through XPath for more information</p>

Example:

```
<IntegrationBlock id="8765">
  <Title>Social Sciences</Title>
  <Description> Each discipline will be taught on the same framework: genes, proteins, cells, tissues,
organs, systems, individuals, communities, environments, and societies. This framework allows basic
science to be taught using evidence-based medicine and a public health perspective.</Description>
  <CompetencyObjectReference>/CurriculumInventory/Expectations/CompetencyObject [
lom:lom/lom:general/lom:identifier/lom:entry='http://www.example.org/zxcvb']</CompetencyObjectReference>
  <EventReference>/CurriculumInventory/Events/Event[@id='23456']</EventReference>
  <SequenceBlockReference>/CurriculumInventory/Sequence/SequenceBlock[@id='asdfg']</SequenceBlockReferen
ce>
</IntegrationBlock>
```

10.0 Sample XML Document

```

<?xml version="1.0" encoding="UTF-8"?>
<CurriculumInventory
  xsi:schemaLocation="http://ns.medbiq.org/curriculuminventory/v1/
  curriculuminventory.xsd"
  xmlns="http://ns.medbiq.org/curriculuminventory/v1/"
  xmlns:lom="http://ltsc.ieee.org/xsd/LOM"
  xmlns:a="http://ns.medbiq.org/address/v1/"
  xmlns:cf="http://ns.medbiq.org/competencyframework/v1/"
  xmlns:co="http://ns.medbiq.org/competencyobject/v1/"
  xmlns:hx="http://ns.medbiq.org/lom/extend/v1/"
  xmlns:m="http://ns.medbiq.org/member/v1/"
  xmlns:xsi="http://www.w3.org/2001/XMLSchema-instance">
  <ReportID domain="idd:nosuch.edu:cip">12345</ReportID>
  <Institution>
    <m:InstitutionName>NoSuch University School of
  Medicine</m:InstitutionName>
    <m:InstitutionID
  domain="idd:aamc.org:institution">987</m:InstitutionID>
    <m:Address>
      <a:StreetAddressLine>720 Main Street</a:StreetAddressLine>
      <a:City>Baltimore</a:City>
      <a:StateOrProvince>MD</a:StateOrProvince>
      <a:PostalCode>21205</a:PostalCode>
      <a:Country>
        <a:CountryCode>US</a:CountryCode>
      </a:Country>
    </m:Address>
  </Institution>
  <Program>
    <ProgramName>M.D.</ProgramName>
    <ProgramID domain="idd:aamc.org:program">5678</ProgramID>
  </Program>
  <Title>NoSuch School of Medicine Curriculum 2010-2011</Title>
  <ReportDate>2011-07-01</ReportDate>
  <ReportingStartDate>2010-07-01</ReportingStartDate>
  <ReportingEndDate>2011-06-30</ReportingEndDate>
  <Language>en-us</Language>
  <Description>The NoSuch curriculum reframes the context of health and
  illness to encourage students to explore a larger, integrated
  system.</Description>
  <SupportingLink>http://www.nosuchmedicine.org/crc/</SupportingLink>
  <Events>
    <Event id="E1">
      <Title>White Coat Ceremony</Title>
      <EventDuration>PT2H</EventDuration>
    </Event>
  </Events>
</CurriculumInventory>

```



```

    <Description>First year students are given their white coats to
    mark the transition to clinical rotations. The ceremony includes a
    declaration of professional values. </Description>

```

```

    <Keyword hx:source="MeSH" hx:id="D010817">
      <hx:string>Physician-Patient Relations</hx:string>
    </Keyword>
    <Keyword hx:source="MeSH" hx:id="D012945">
      <hx:string>Social Values</hx:string>
    </Keyword>
    <Interprofessional>>false</Interprofessional>

```

```

    <CompetencyObjectReference>/CurriculumInventory/Expectations/Competency
    Object [lom:lom/lom:general/lom:identifier/lom:entry='http://nosuchdomain.e
    du/zxcvb']</CompetencyObjectReference>

```

```

    <InstructionalMethod primary="true"
    instructionalMethodDuration="PT2H">Lecture</InstructionalMethod>
  </Event>

```

```

  <Event id="E2">

```

```

    <Title>Orientation Lecture</Title>
    <EventDuration>PT4H</EventDuration>

```

```

    <Description>Faculty discuss what the students are to expect in
    the coming year.</Description>

```

```

    <Keyword hx:source="MeSH" hx:id="D010817">
      <hx:string>Physician-Patient Relations</hx:string>
    </Keyword>
    <Keyword hx:source="MeSH" hx:id="D012945">
      <hx:string>Social Values</hx:string>
    </Keyword>
    <Interprofessional>>false</Interprofessional>

```

```

    <CompetencyObjectReference>/CurriculumInventory/Expectations/Competency
    Object [lom:lom/lom:general/lom:identifier/lom:entry='http://nosuchdomain.e
    du/zxcvb']</CompetencyObjectReference>

```

```

    <InstructionalMethod primary="true"
    instructionalMethodDuration="PT3H">Lecture</InstructionalMethod>
  </Event>

```

```

  <Event id="E3">

```

```

    <Title>Peds Part 1</Title>
    <EventDuration>PT20H</EventDuration>
    <Description>Students shadow Pediatricians</Description>
    <InstructionalMethod primary="true">Clinical Experience -

```

```

    Inpatient</InstructionalMethod>
  </Event>

```

```

  <Event id="E4">

```

```

    <Title>Peds Part 2</Title>
    <EventDuration>PT20H</EventDuration>

```

```

    <Description>Students talk to families and take history with
    supervision</Description>

```

```

    <InstructionalMethod primary="true">Clinical Experience -
Inpatient</InstructionalMethod>
  </Event>
  <Event id="E5">
    <Title>Geriatrics Part 1</Title>
    <EventDuration>PT20H</EventDuration>
    <Description>Students shadow Geriatricians</Description>
    <InstructionalMethod primary="true">Clinical Experience -
Ambulatory</InstructionalMethod>
  </Event>
  <Event id="E6">
    <Title>Geriatrics Part 2</Title>
    <EventDuration>PT20H</EventDuration>
    <Description>Students talk to families and take history with
supervision</Description>
    <InstructionalMethod primary="true">Clinical Experience -
Ambulatory</InstructionalMethod>
  </Event>
</Events>
<Expectations>
  <CompetencyObject>
    <lom:lom>
      <lom:general>
        <lom:identifier>
          <lom:catalog>URI</lom:catalog>
          <lom:entry>http://nosuchdomain.edu/zxcvb</lom:entry>
        </lom:identifier>
        <lom:title>
          <lom:string>Professionalism</lom:string>
        </lom:title>
      </lom:general>
    </lom:lom>
  </CompetencyObject>
  <CompetencyFramework>
    <lom:lom>
      <lom:general>
        <lom:identifier>
          <lom:catalog>URI</lom:catalog>
          <lom:entry>http://nosuchdomain.edu/framework</lom:entry>
        </lom:identifier>
      </lom:general>
      <lom:lifeCycle>
        <lom:version>
          <lom:string>1.0</lom:string>
        </lom:version>
      </lom:lifeCycle>
    </lom:lom>
  <cf:Includes>
    <cf:Catalog>URI</cf:Catalog>

```

```

        <cf:Entry>http://nosuchdomain.edu/zxcvb</cf:Entry>
    </cf:Includes>
</CompetencyFramework>
</Expectations>
<AcademicLevels>
    <LevelsInProgram>4</LevelsInProgram>
    <Level number="1">
        <Label>Year 1</Label>
        <Description>Preclinical</Description>
    </Level>
    <Level number="2">
        <Label>Year 2</Label>
        <Description>Preclinical</Description>
    </Level>
    <Level number="3">
        <Label>Year 3</Label>
        <Description>Clinical</Description>
    </Level>
    <Level number="4">
        <Label>Year 4</Label>
        <Description>Clinical</Description>
    </Level>
</AcademicLevels>
<Sequence>
    <SequenceBlock id="c" required="Required">
        <Title>Year 1</Title>
        <Timing>
            <Duration>P12M</Duration>
        </Timing>

    <Level>/CurriculumInventory/AcademicLevels/Level [@number='1']</Level>

    <CompetencyObjectReference>/CurriculumInventory/Expectations/Competency
Object [lom:lom/lom:general/lom:identifier/lom:entry='http://nosuchdomain.e
du/zxcvb']</CompetencyObjectReference>

    <SequenceBlockReference>/CurriculumInventory/Sequence/SequenceBlock[@id
='e']</SequenceBlockReference>

    <SequenceBlockReference>/CurriculumInventory/Sequence/SequenceBlock[@id
='f']</SequenceBlockReference>
    </SequenceBlock>
    <SequenceBlock id="e" required="Required">
        <Title>Introduction to Medicine</Title>
        <Timing>
            <Duration>P1M</Duration>
        </Timing>

    <Level>/CurriculumInventory/AcademicLevels/Level [@number='1']</Level>

```

```

    <SequenceBlockEvent required="true">

    <EventReference>/CurriculumInventory/Events/Event[@id='E1']</EventRefer
ence>
    </SequenceBlockEvent>
  </SequenceBlock>
  <SequenceBlock id="f" required="Required">
    <Title>Orientation</Title>
    <Timing>
      <Duration>P1M</Duration>
    </Timing>

    <Level>/CurriculumInventory/AcademicLevels/Level[@number='1']</Level>
    <SequenceBlockEvent required="true">

    <EventReference>/CurriculumInventory/Events/Event[@id='E2']</EventRefer
ence>
    </SequenceBlockEvent>
  </SequenceBlock>
  <SequenceBlock id="d" required="Required">
    <Title>Year 2</Title>
    <Timing>
      <Dates>
        <StartDate>2010-07-01</StartDate>
        <EndDate>2011-06-30</EndDate>
      </Dates>
    </Timing>

    <Level>/CurriculumInventory/AcademicLevels/Level[@number='2']</Level>
    <Precondition>Requires successful completion of Year
1.</Precondition>
    <SequenceBlockEvent required="true">

    <EventReference>/CurriculumInventory/Events/Event[@id='E3']</EventRefer
ence>
    </SequenceBlockEvent>
  <SequenceBlockEvent required="true">

  <EventReference>/CurriculumInventory/Events/Event[@id='E4']</EventRefer
ence>
  </SequenceBlockEvent>
</SequenceBlock>
</Sequence>
</CurriculumInventory>

```

11.0 References

Competency Framework

MedBiquitous Competency Framework Specifications and Description Document. MedBiquitous website. http://www.medbiq.org/working_groups/competencies/CompetencyFrameworkSpecification.pdf. Accessed June 16, 2011.

Competency Object

MedBiquitous Competency Object Specifications and Description Document. MedBiquitous Website. <http://www.medbiq.org/sites/default/files/CompetencyObjectSpecification.pdf>. Accessed June 16, 2011.

Healthcare LOM

MEDBIQ LO.10.1-2008, Healthcare Learning Object Metadata (Healthcare LOM). MedBiquitous Website. http://www.medbiq.org/std_specs/standards/index.html#HCLOM. Accessed June 1, 2011.

Professional Profile

MEDBIQ PP.10.1-2008, Healthcare Professional Profile. MedBiquitous Website. http://www.medbiq.org/std_specs/standards/index.html#HCPProfProfile Accessed June 13, 2011.

URI

Berners-Lee T., Fielding R., Masinter L. , 2005. RFC 3986: Uniform Resource Identifier (URI): Generic Syntax. Accessed February 21, 2013.

Vocabularies

Curriculum Inventory Standardized Instructional and Assessment Methods and Resource Types. <http://medbiq.org/curriculum/vocabularies.pdf>

XSD

Extensible Markup Language (XML) 1.0 (Fifth Edition), W3C Website. 26 November 2008 <http://www.w3.org/TR/2008/REC-xml-20081126/> . Accessed March 20, 2012.